











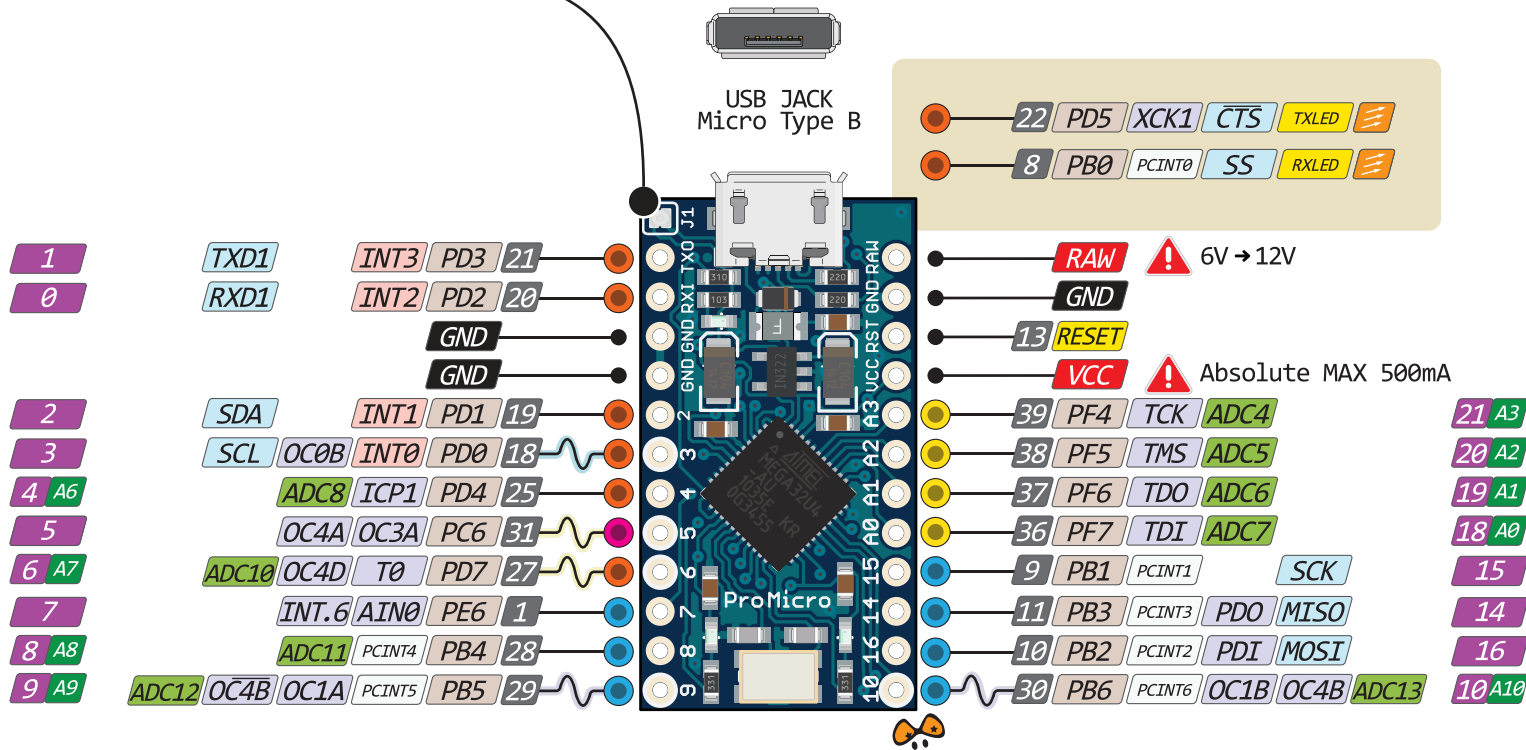





PROMICRO

 The power sum for each pin's group should not exceed 100mA

Closed for 5V boards 
Open for 3.3V boards



-  Power
-  GND
-  Serial Pin
-  Analog Pin
-  Control
-  INT
-  Physical Pin
-  Port Pin
-  Pin function
-  Interrupt Pin
-  PWM Pin
-  Port Power 

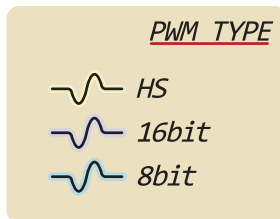

 Absolute MAX per pin 10mA
recommended 5mA

 Absolute MAX 150mA
for entire package

